

N - CHANNEL ENHANCEMENT MODE POWER MOS TRANSISTORS

TYPE	V _{DSS}	R _{DS(on)}	I _D ■
IRF620	200 V	0.8 Ω	5 A
IRF620FI	200 V	0.8 Ω	4 A
IRF621	150 V	0.8 Ω	5 A
IRF621FI	150 V	0.8 Ω	4 A
IRF622	200 V	1.2 Ω	4 A
IRF622FI	200 V	1.2 Ω	3.5 A
IRF623	150 V	1.2 Ω	4 A
IRF623FI	150 V	1.2 Ω	3.5 A

- 200V FOR TELECOMMUNICATION APPLICATIONS
- ULTRA FAST SWITCHING
- RATED FOR UNCLAMPED INDUCTIVE SWITCHING (ENERGY TEST) ♦
- EASY DRIVE - REDUCES COST AND SIZE

INDUSTRIAL APPLICATIONS:

- SWITCHING MODE POWER SUPPLIES
- DC SWITCH
- ROBOTCS

N - channel enhancement mode POWER MOS field effect transistors. Easy drive and very fast switching times make these POWER MOS transistors ideal for high speed switching applications. Typical uses are in telecommunications, robotics, switching power supplies and as a DC switch.

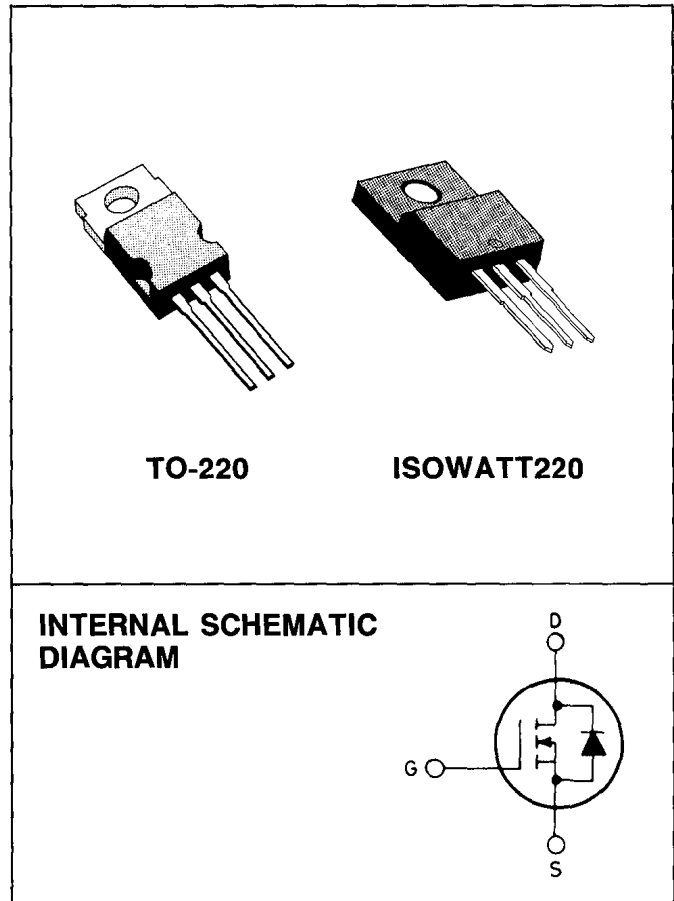

ABSOLUTE MAXIMUM RATINGS

		IRF					
		TO-220 ISOWATT220	620 620FI	621 621FI	622 622FI		623 623FI
V _{DS} *	Drain-source voltage (V _{GS} = 0)		200	150	200	150	V
V _{DGR} *	Drain-gate voltage (R _{GS} = 20 KΩ)		200	150	200	150	V
V _{GS}	Gate-source voltage				±20		V
I _{DM} (•)	Drain current (pulsed)		20	20	16	16	A
I _D	Drain current (cont.) at T _c = 25°C		5	5	4	4	A
I _D	Drain current (cont.) at T _c = 100°C		3	3	2.5	2.5	A
I _D ■	Drain current (cont.) at T _c = 25°C		4	4	3.5	3.5	A
I _D ■	Drain current (cont.) at T _c = 100°C		2.5	2.5	2	2	A
P _{tot}	Total dissipation at T _c < 25°C		TO-220		ISOWATT220		
	Derating factor		40		30		W
			0.32		0.24		W/°C
T _{stg}	Storage temperature		-55 to 150				°C
T _j	Max. operating junction temperature		150				°C

- * T_j = 25°C to 125°C
- (•) Repetitive Rating: Pulse width limited by max junction temperature.
- See note on ISOWATT220 on this datasheet.
- ♦ Introduced in 1988 week 44

THERMAL DATA

TO-220 | ISOWATT220

$R_{thj - case}$	Thermal resistance junction-case	max	3.12	4.16	°C/W
R_{thc-s}	Thermal resistance case-sink	typ	0.5		°C/W
$R_{thj-amb}$	Thermal resistance junction-ambient	max	80		°C/W
T_l	Maximum lead temperature for soldering purpose		300		°C

ELECTRICAL CHARACTERISTICS ($T_{case} = 25^\circ\text{C}$ unless otherwise specified)

Parameters	Test Conditions	Min.	Typ.	Max.	Unit
------------	-----------------	------	------	------	------

OFF

$V_{(BR) DSS}$	Drain-source breakdown voltage	$I_D = 250 \mu\text{A}$ for IRF620/622/620FI/622FI for IRF621/623/621FI/623FI	$V_{GS} = 0$	200 150		V V
I_{DSS}	Zero gate voltage drain current ($V_{GS} = 0$)	$V_{DS} = \text{Max Rating}$ $V_{DS} = \text{Max Rating} \times 0.8$	$T_c = 125^\circ\text{C}$		250 1000	μA μA
I_{GSS}	Gate-body leakage current ($V_{DS} = 0$)	$V_{GS} = \pm 20 \text{ V}$			± 500	nA

ON **

$V_{GS(th)}$	Gate threshold voltage	$V_{DS} = V_{GS}$	$I_D = 250 \mu\text{A}$	2		4	V
$I_{D(on)}$	On-state drain current	$V_{DS} > I_{D(on)} \times R_{DS(on) max}$ for IRF620/621/620FI/621FI for IRF622/623/622FI/623FI	$V_{GS} = 10 \text{ V}$	5 4			A A
$R_{DS(on)}$	Static drain-source on resistance	$V_{GS} = 10 \text{ V}$ for IRF620/621/620FI/621FI for IRF622/623/622FI/623FI	$I_D = 2.5 \text{ A}$			0.8 1.2	Ω Ω

ENERGY TEST

I_{UIS}	Unclamped inductive switching current (single pulse)	$V_{DD} = 30 \text{ V}$ starting $T_j = 25^\circ\text{C}$ for IRF620/621/620FI/621FI for IRF622/623/622FI/623FI	$L = 100 \mu\text{H}$	5 4			A A
-----------	--	--	-----------------------	--------	--	--	--------

DYNAMIC

$g_{fs} **$	Forward transconductance	$V_{DS} > I_{D(on)} \times R_{DS(on) max}$ $I_D = 2.5 \text{ A}$		1.3			mho
C_{iss} C_{oss} C_{rss}	Input capacitance Output capacitance Reverse transfer capacitance	$V_{DS} = 25 \text{ V}$ $V_{GS} = 0$	$f = 1 \text{ MHz}$			600 300 80	pF pF pF

ELECTRICAL CHARACTERISTICS (Continued)

Parameters	Test Conditions	Min.	Typ.	Max.	Unit
t_d (on) t_r t_d (off) t_f	Turn-on time Rise time Turn-off delay time Fall time $V_{DD} = 75\text{ V}$ $R_i = 50\ \Omega$ $I_D = 2.5\text{ A}$ (see test circuit)			40 60 100 60	ns ns ns ns
Q_g	Total Gate Charge $V_{GS} = 10\text{ V}$ $V_{DS} = \text{Max Rating} \times 0.8$ (see test circuit) $I_D = 6\text{ A}$			15	nC

SOURCE DRAIN DIODE

I_{SD} I_{SDM} (*)	Source-drain current Source-drain current (pulsed)			5 20	A A
V_{SD} **	Forward on voltage	for IRF620/621/620FI/621FI $I_{SD} = 5\text{ A}$ for IRF622/623/622FI/623FI $I_{SD} = 4\text{ A}$	$V_{GS} = 0$ $V_{GS} = 0$	1.8 1.4	V V
t_{rr} Q_{rr}	Reverse recovery time Reverse recovered charge	$I_{SD} = 5\text{ A}$	$di/dt = 100\text{ A}/\mu\text{s}$	350 2.3	ns μC

** Pulsed: Pulse duration $\leq 300\ \mu\text{s}$, duty cycle $\leq 1.5\%$
 (*) Repetitive Rating: Pulse width limited by max junction temperature
 ■ See note on ISOWATT220 In this datasheet

Safe operating areas (standard package)

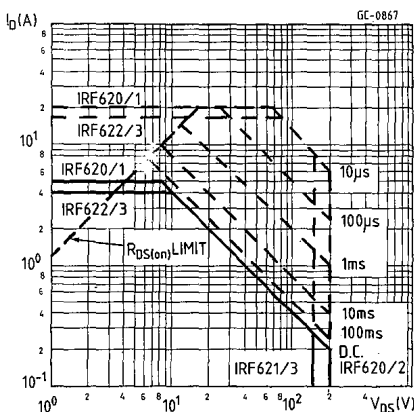

Thermal impedance (standard package)

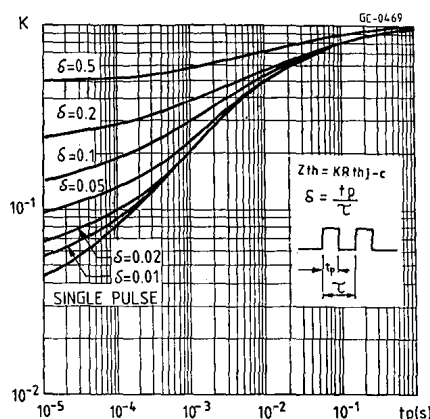

Derating curve (standard package)

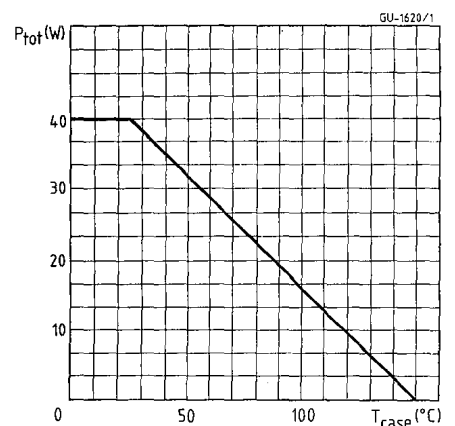

Output characteristics

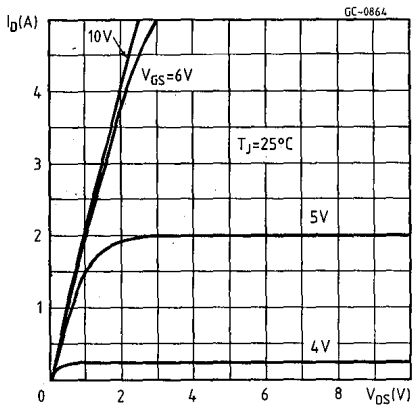

Output characteristics

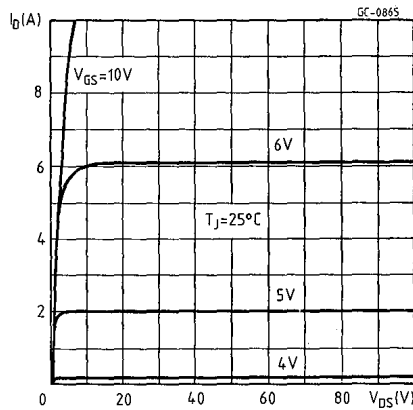

Transfer characteristics

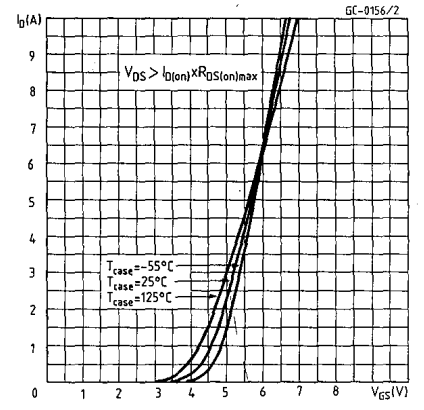

Transconductance

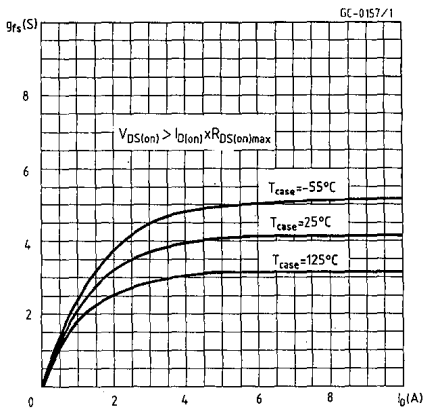

Static drain-source on resistance

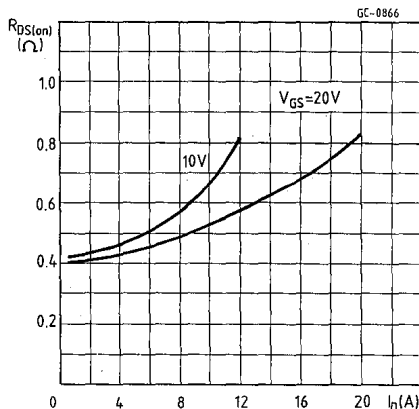

Maximum drain current vs temperature

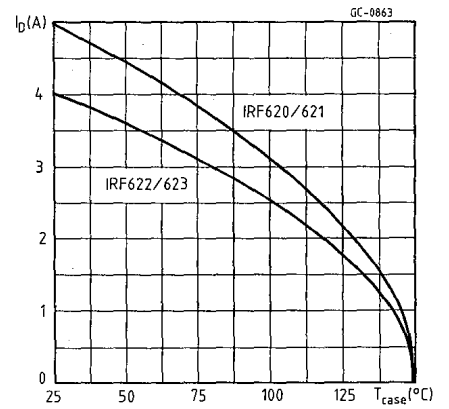

Gate charge vs gate-source voltage

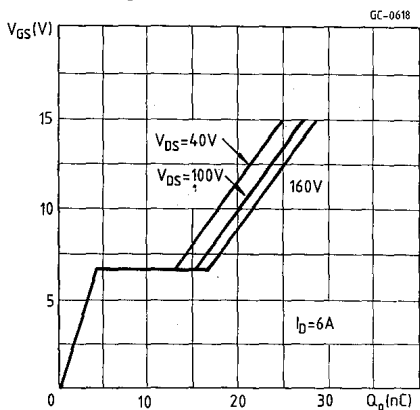

Capacitance variation

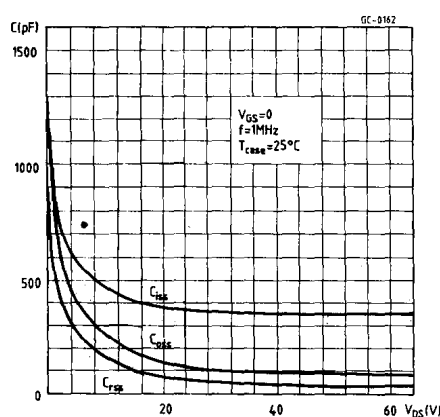

Normalized breakdown voltage vs temperature

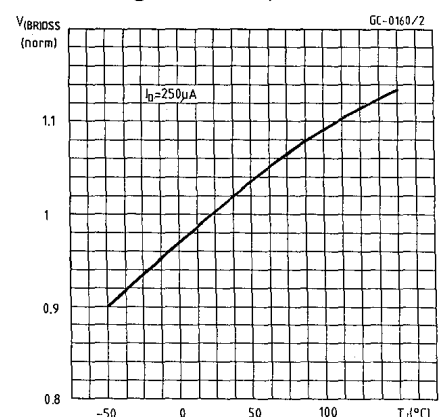

Normalized on resistance vs temperature

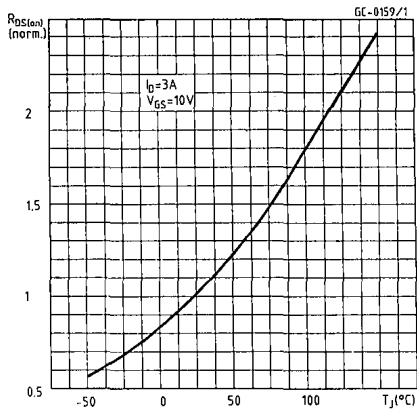

Source-drain diode forward characteristics

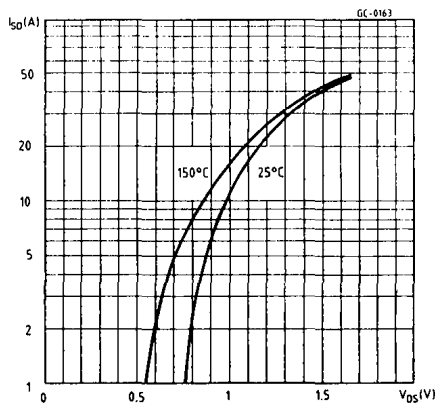

Unclamped inductive test circuit

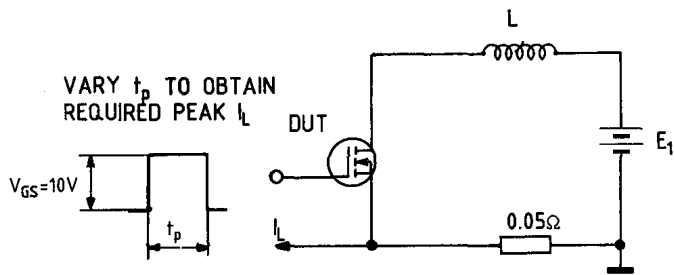

SC-0339

Unclamped inductive waveforms

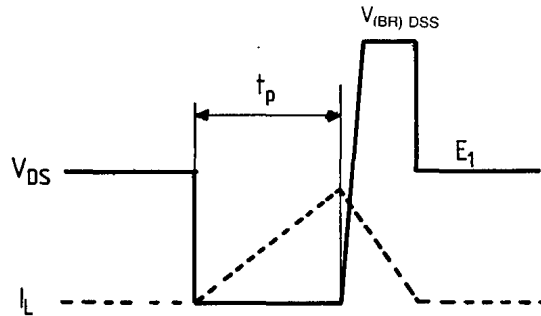

SC-0338

Switching times test circuit

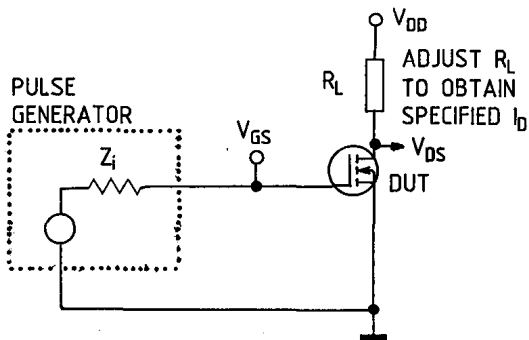

SC-0246

Gate charge test circuit

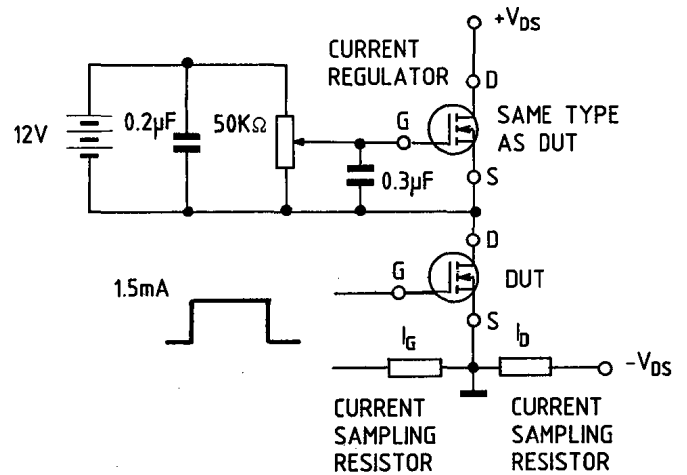

SC-0244

ISOWATT220 PACKAGE CHARACTERISTICS AND APPLICATION.

ISOWATT220 is fully isolated to 2000V dc. Its thermal impedance, given in the data sheet, is optimised to give efficient thermal conduction together with excellent electrical isolation.

The structure of the case ensures optimum distances between the pins and heatsink. The ISOWATT220 package eliminates the need for external isolation so reducing fixing hardware. Accurate moulding techniques used in manufacture assure consistent heat spreader-to-heatsink capacitance.

ISOWATT220 thermal performance is better than that of the standard part, mounted with a 0.1mm mica washer. The thermally conductive plastic has a higher breakdown rating and is less fragile than mica or plastic sheets. Power derating for ISOWATT220 packages is determined by:

$$P_D = \frac{T_j - T_c}{R_{th}}$$

from this I_{Dmax} for the POWER MOS can be calculated:

$$I_{Dmax} \leq \sqrt{\frac{P_D}{R_{DS(on)} \text{ (at } 150^\circ\text{C)}}$$

THERMAL IMPEDANCE OF ISOWATT220 PACKAGE

Fig. 1 illustrates the elements contributing to the thermal resistance of transistor heatsink assembly, using ISOWATT220 package.

The total thermal resistance $R_{th(tot)}$ is the sum of each of these elements.

The transient thermal impedance, Z_{th} for different pulse durations can be estimated as follows:

- 1 - for a short duration power pulse less than 1ms;

$$Z_{th} < R_{thJ-C}$$

- 2 - for an intermediate power pulse of 5ms to 50ms:

$$Z_{th} = R_{thJ-C}$$

- 3 - for long power pulses of the order of 500ms or greater:

$$Z_{th} = R_{thJ-C} + R_{thC-HS} + R_{thHS-amb}$$

It is often possible to discern these areas on transient thermal impedance curves.

Fig. 1

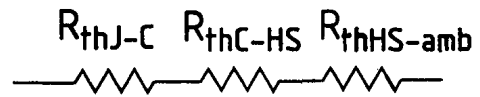

ISOWATT DATA

Safe operating areas

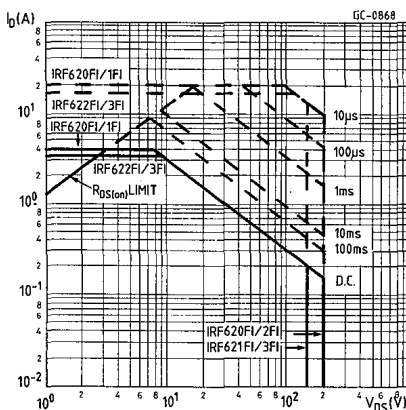

Thermal impedance

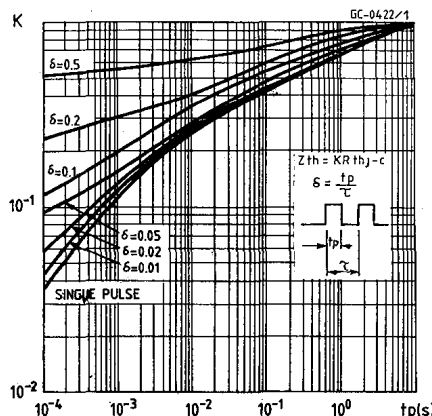

Derating curve

